

# ICAB

## FEA applied to hydraulic structures

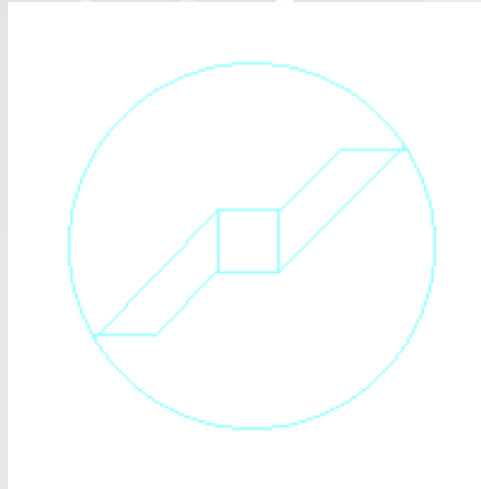

Quit

internet: <http://www.icab.fr/>

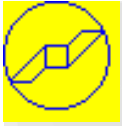

# Design and FE Analysis

- Graphical data capture interface :
  - General view:

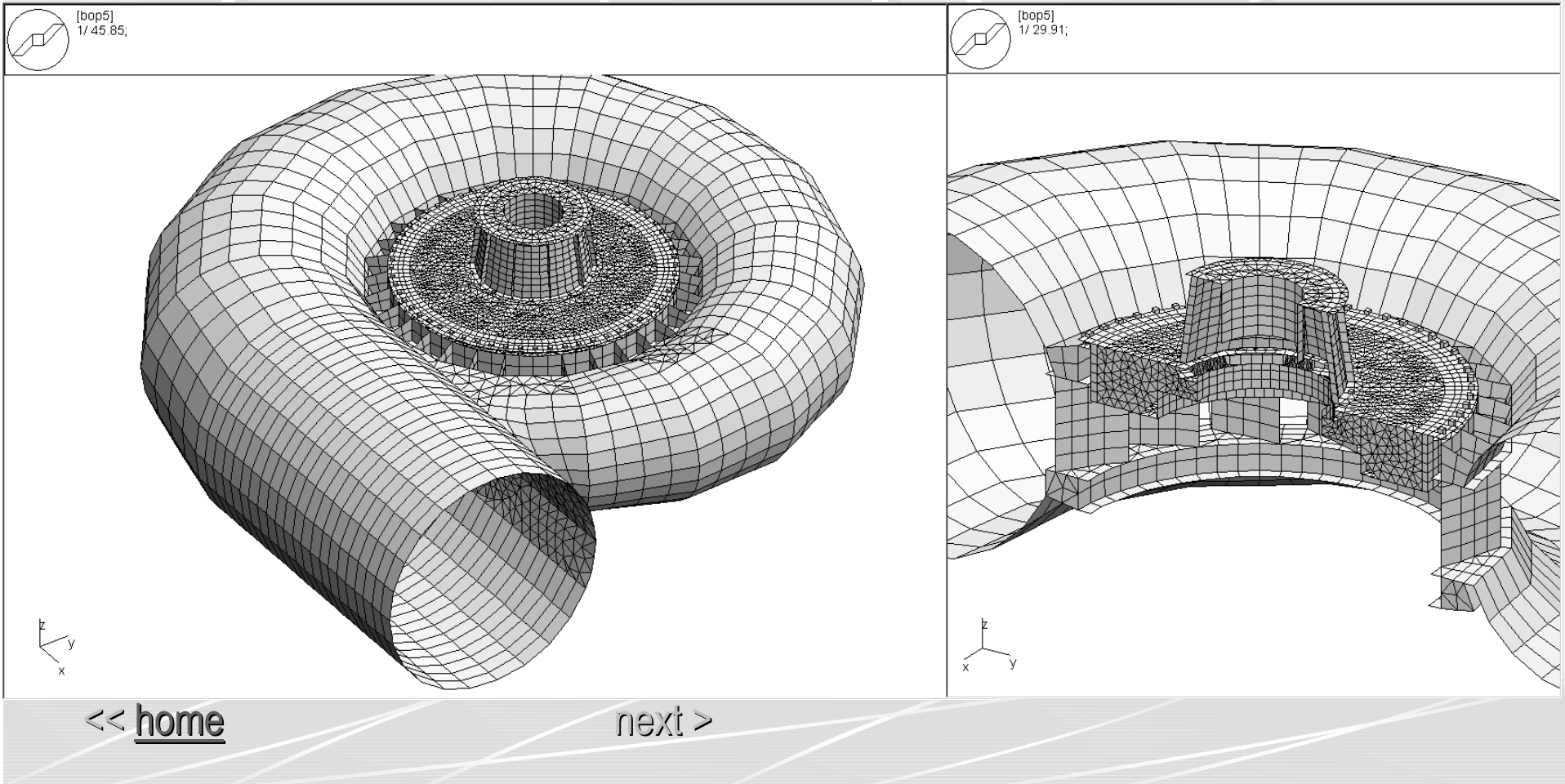

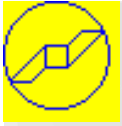

# CAD data input

- Import IGES (or DXF AutoCAD) file

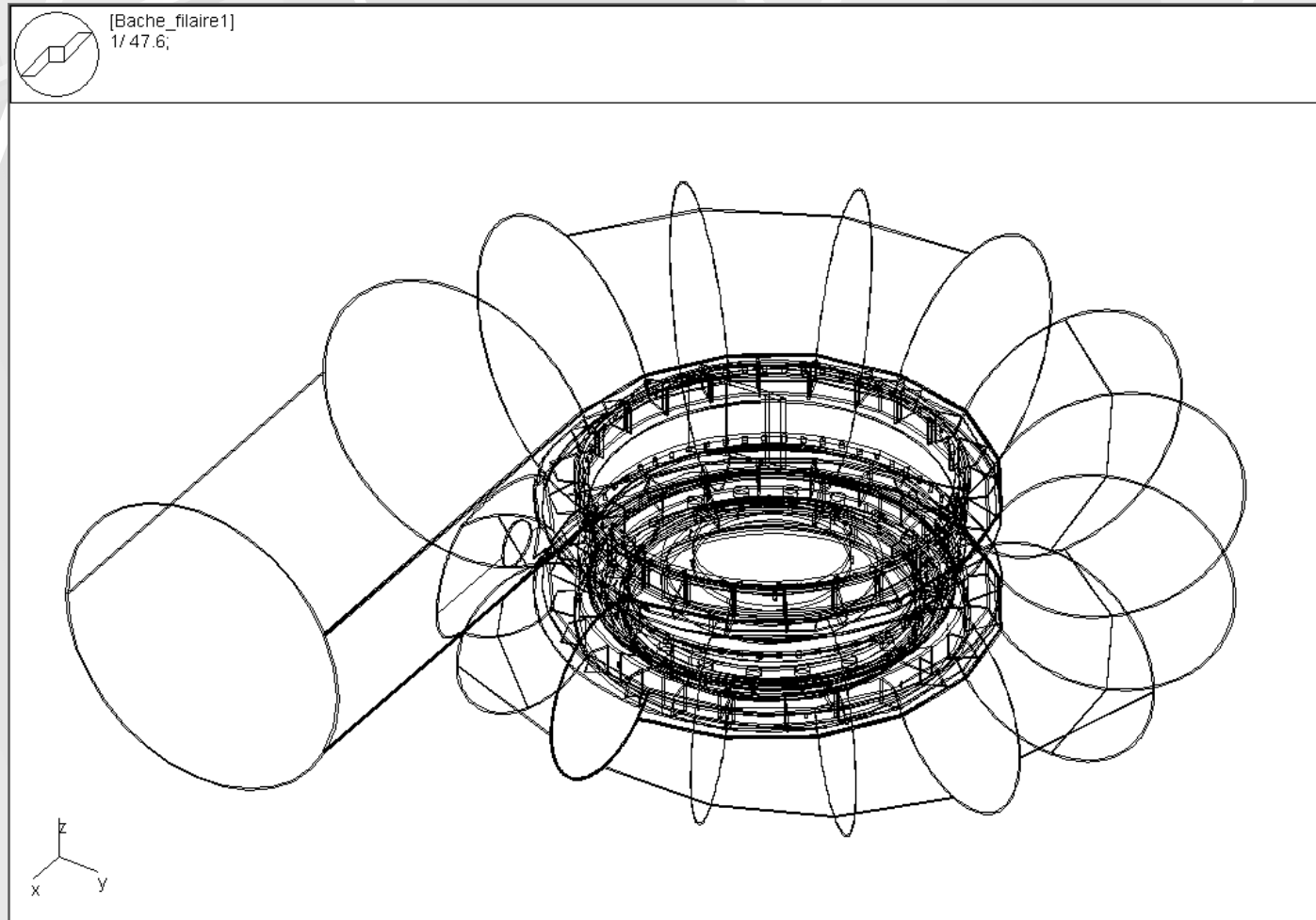

<< home

next >

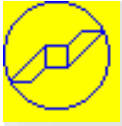

# CAD detail

- Detail of the import

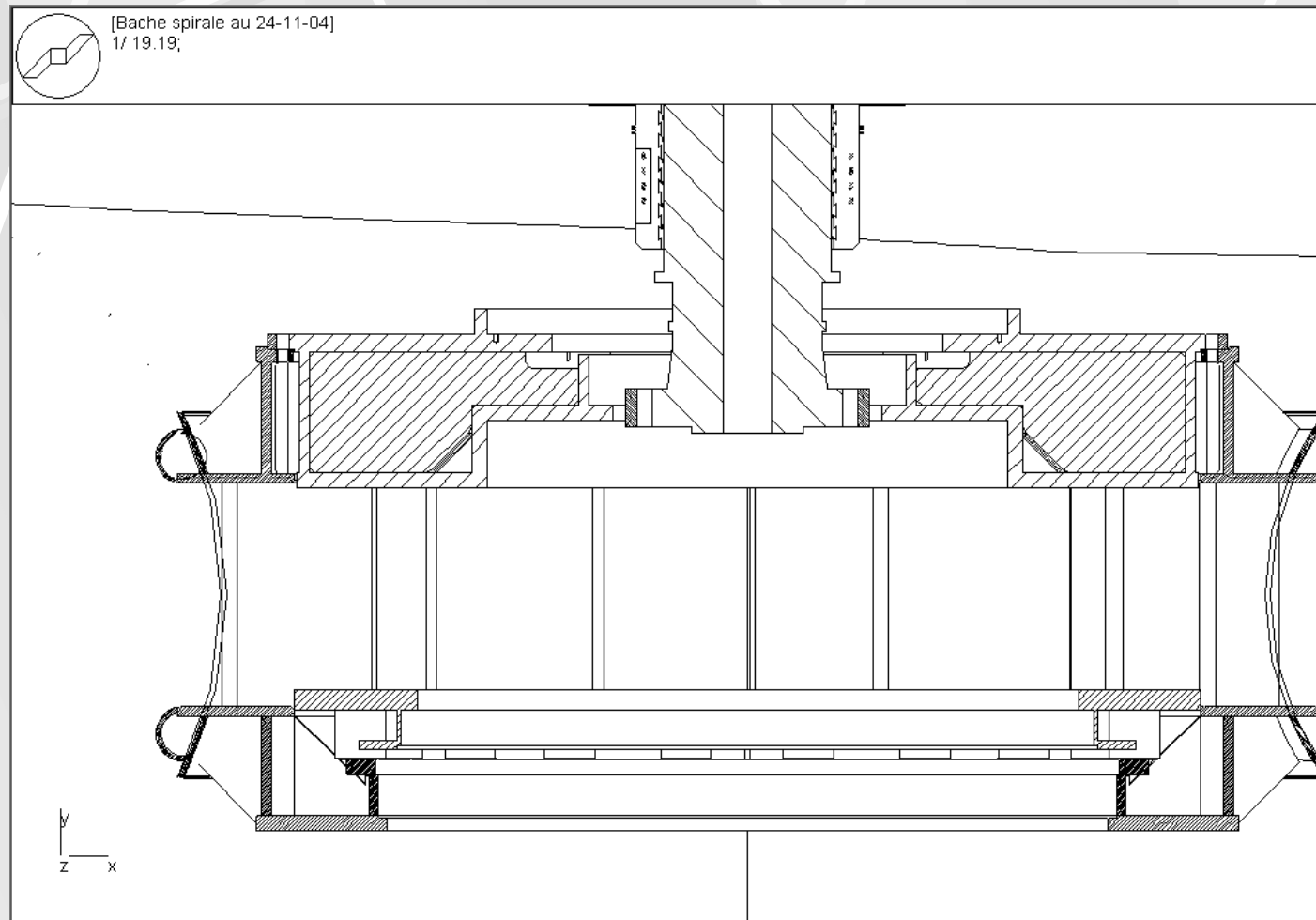

<< home

next >

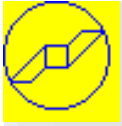

# Meshing

- Meshing :
- Preliminary mesh



[bop\_bache\_flasque\_B041124\_mesh]  
1/ 7.175;

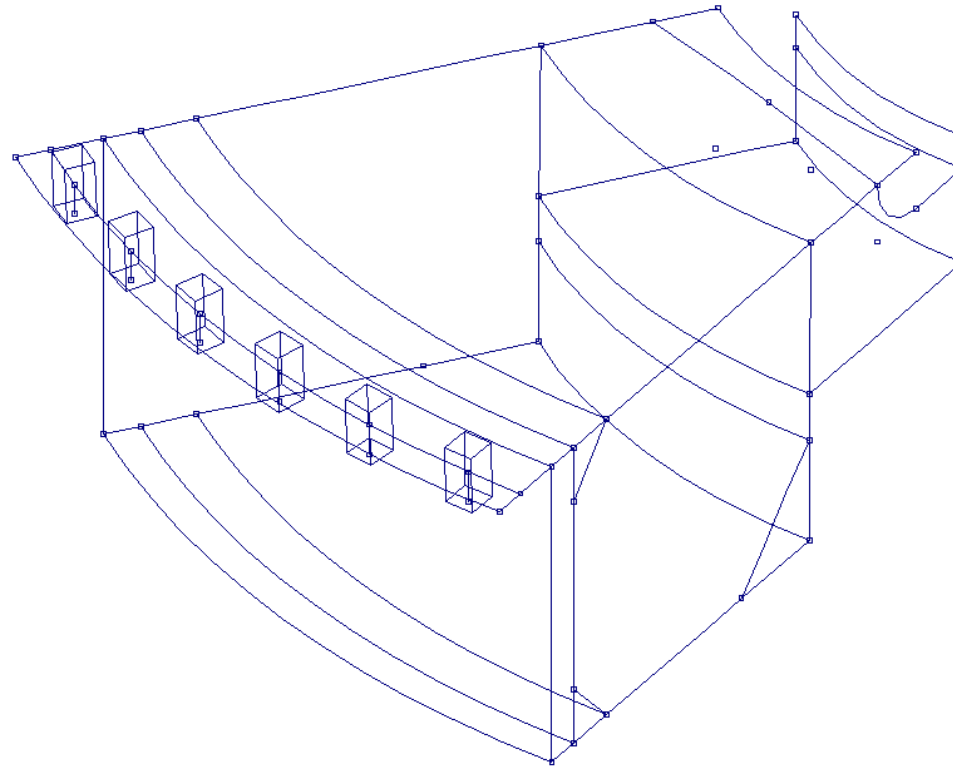

<< home

next >

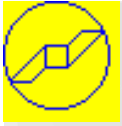

# Finite element Meshing

- Creation of the shell elements

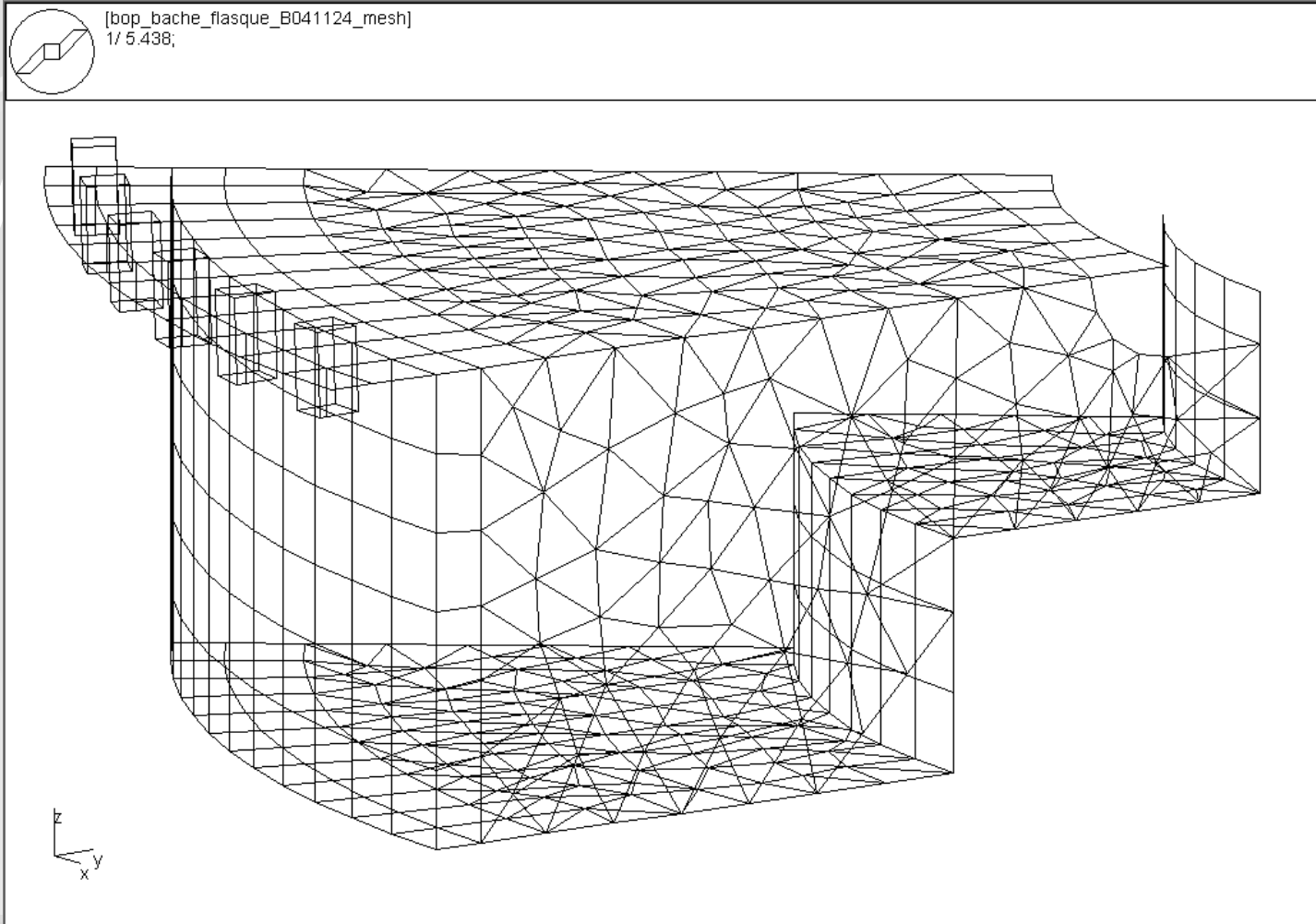

<< home

next >

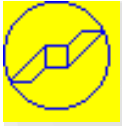

# Model completion

- Completion of the meshing by rotation

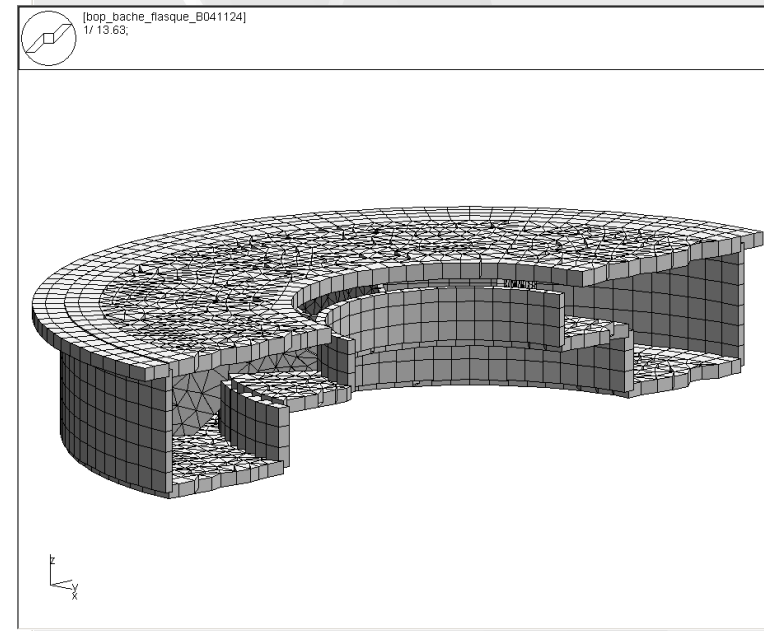
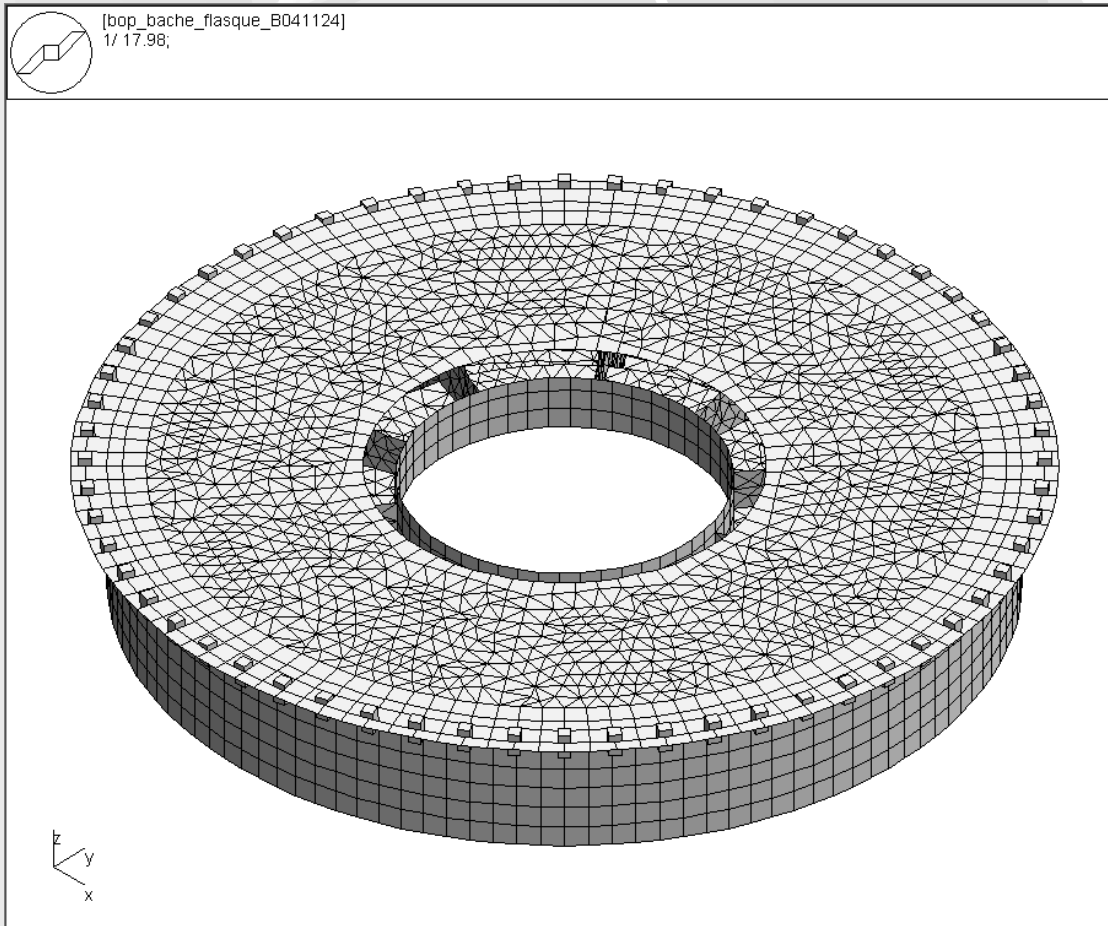

<< home

next >

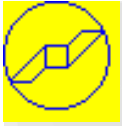

# Pressure load

- Applying of boundary conditions :
  - Pressure = 12 bars :

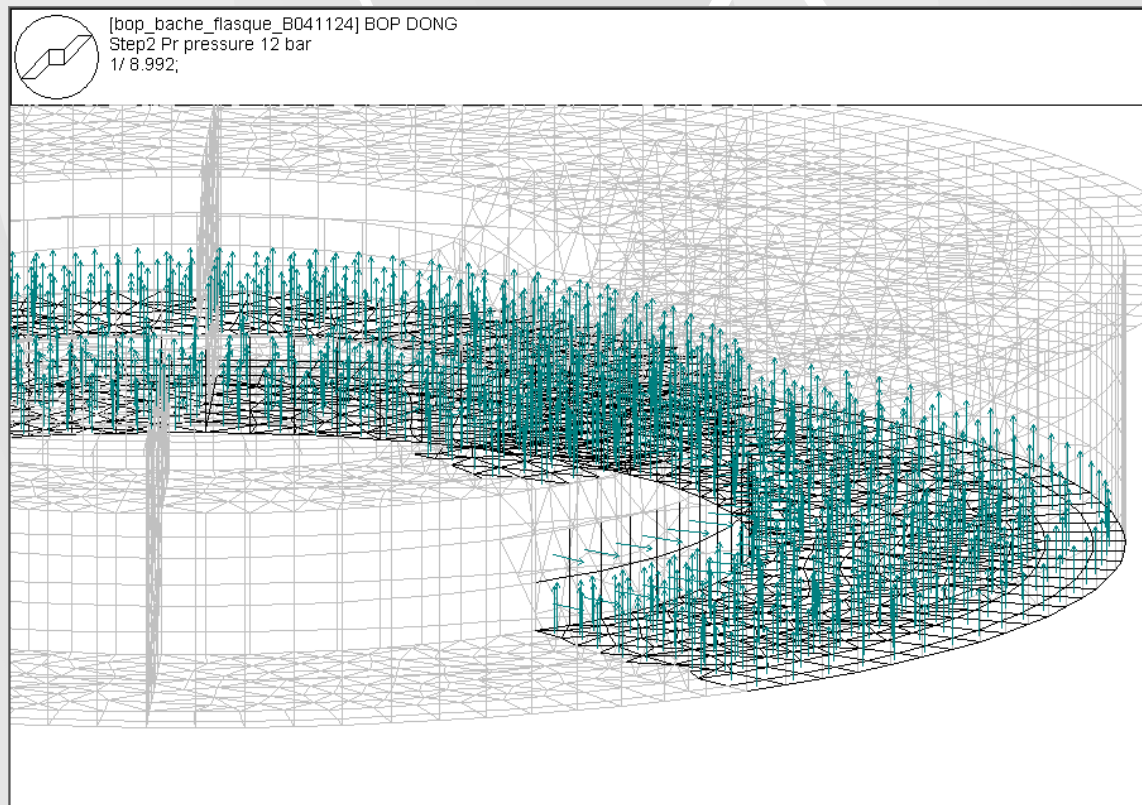



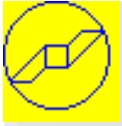

# Assemble parts

- Assembly of the other parts :
  - + cover with bearing

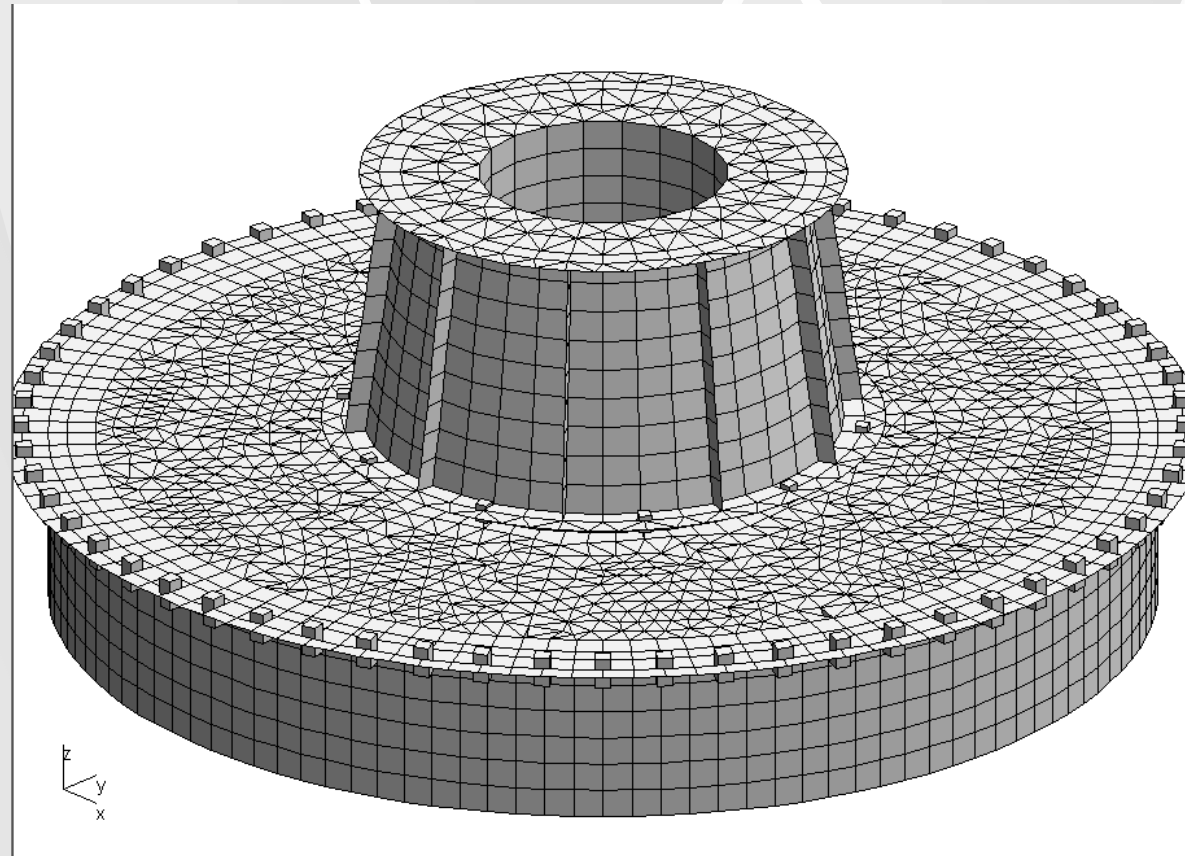

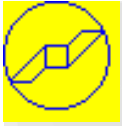

# Assemble parts (2)

- + support of the case

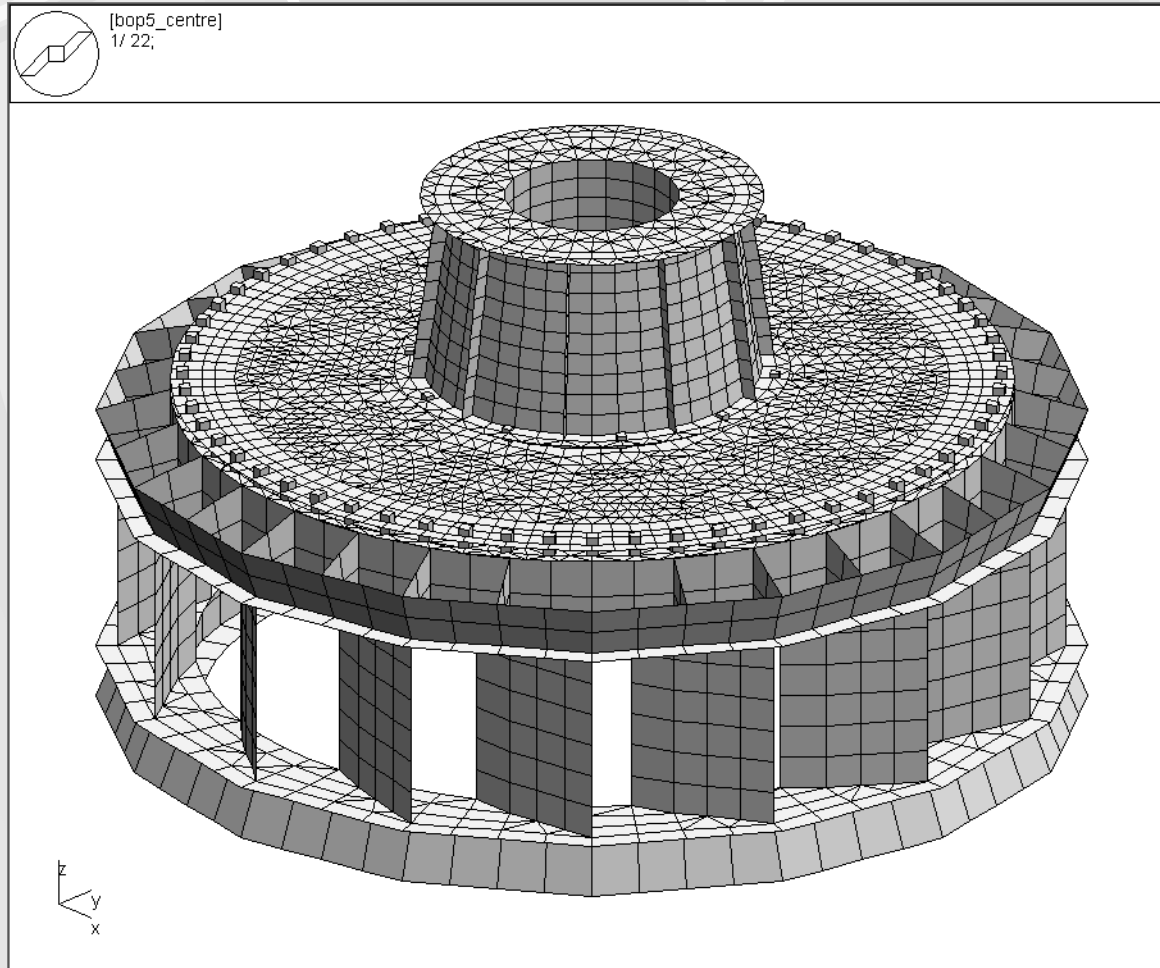

<< home

next >

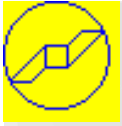

# Assemble parts (3)

- The full structure

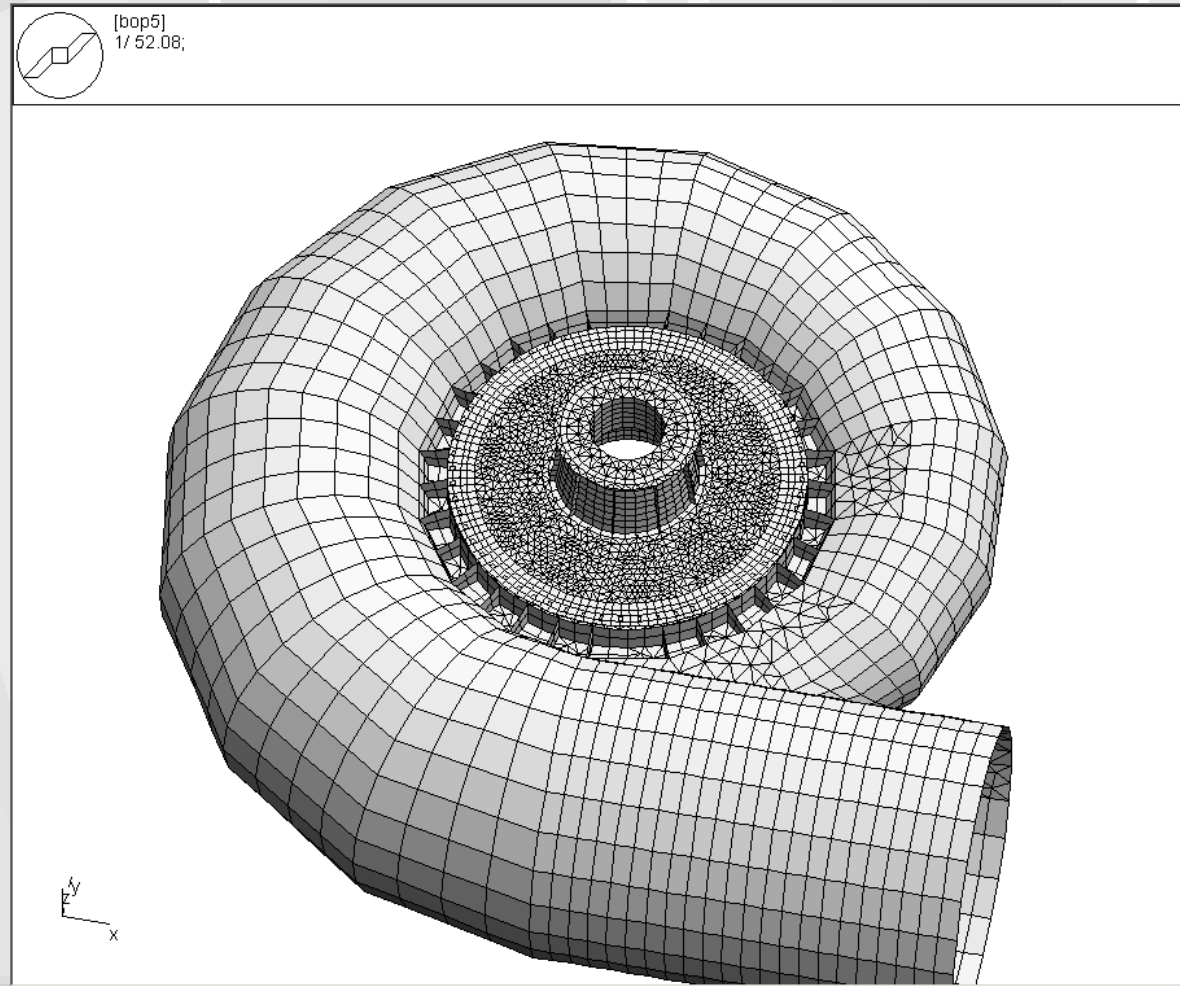

<< home

next >

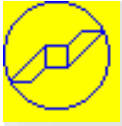

# Results - stresses

- Visual output :
  - Stresses

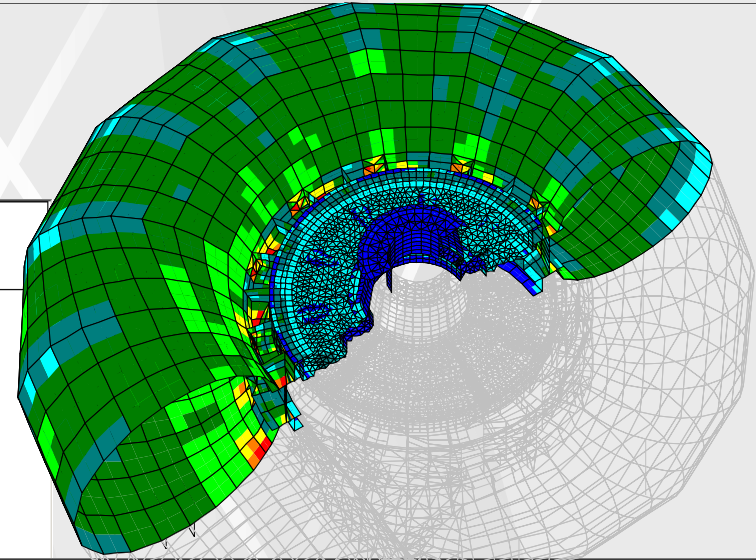
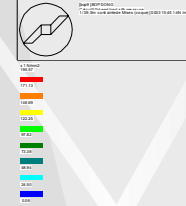

[bop5\_top] BOP DONG  
Calcul3 G dead load + Pr pressure  
1/ 22.55; Sm contrainte de Mises (coque) [0.01049; 126.6 N/mm2]

x 1 N/mm2

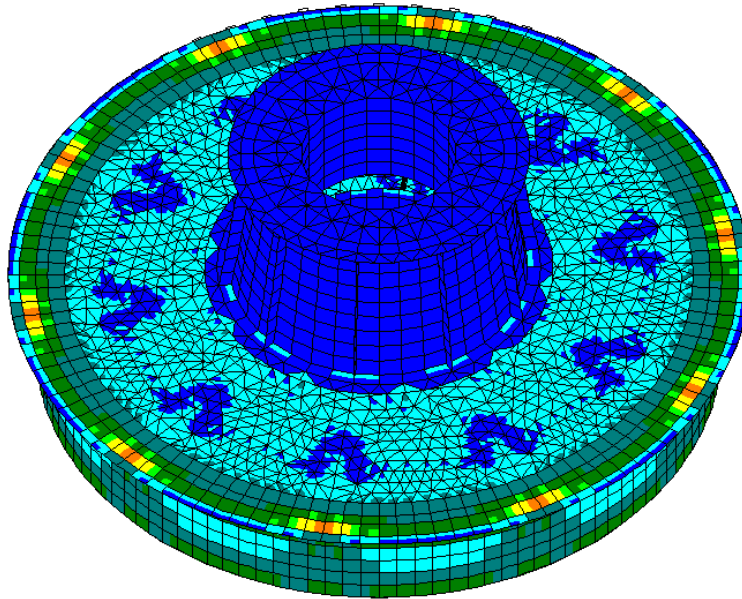
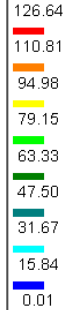

[bop5\_top] BOP DONG  
Calcul3 G dead load + Pr pressure  
1/ 14.88; Sm contrainte de Mises (coque) [0.01049; 126.6 N/mm2]

x 1 N/mm2

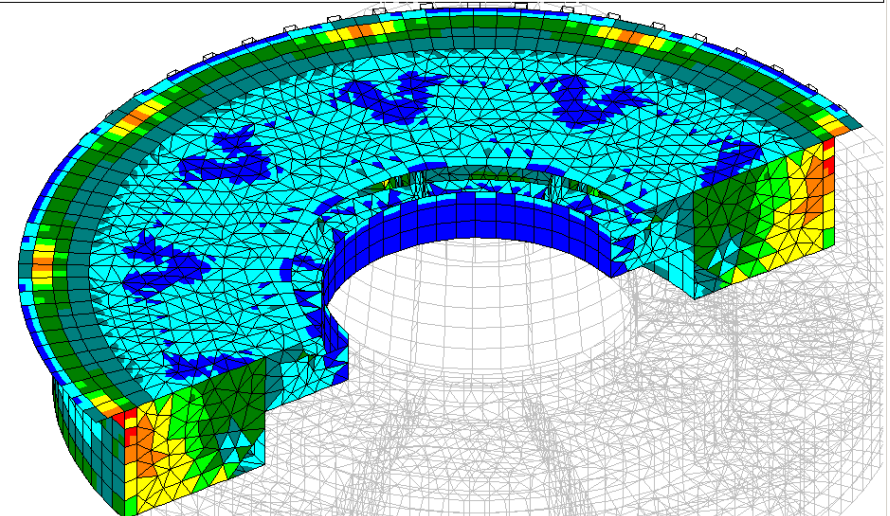
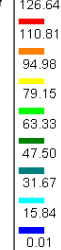

<< home

next >

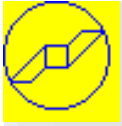

# Results -displacement

- Deflection

[bop5\_top] BOP DONG  
Step3 G dead load + Pr pressure  
1/ 14.88; W deflection of the shell (norm) [1.519E-008; 1.193 mm]

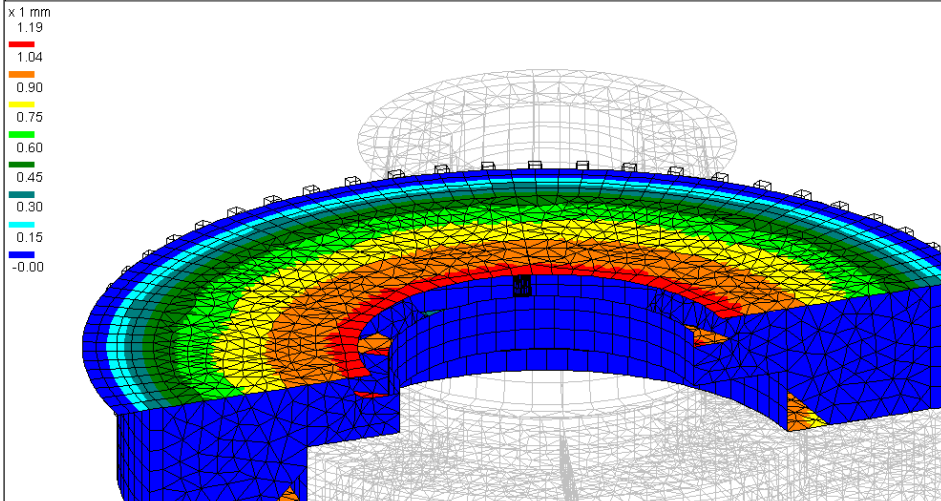

[bop5\_top] BOP DONG  
Step3 G dead load + Pr pressure  
1/ 17.55; (deform x 250)

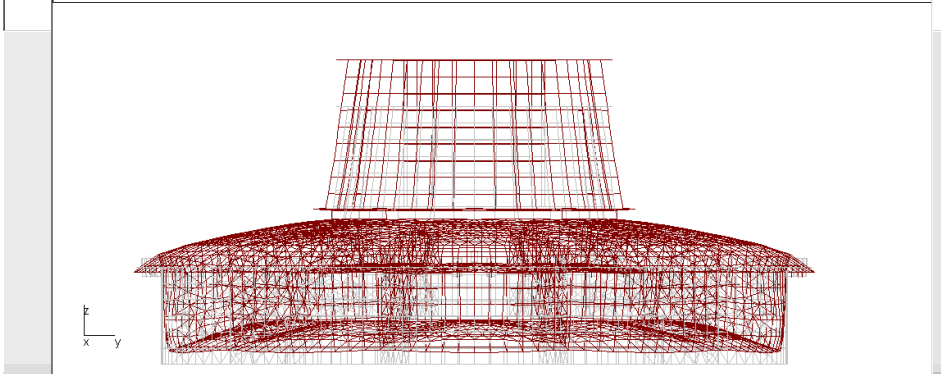

[bop5\_top] BOP DONG  
Step3 G dead load + Pr pressure  
1/ 9.814; W deflection of the she

Node	X displacement mm	Y displacement mm	Z displacement mm	RX rotation rad	RY rotation rad	RZ rotation rad	D full displac mm	R full rotatio rad
489	1.682e-5	-0.0002211	1.033	5.405e-6	6.993e-16	-4.205e-8	1.033	5.405e-6

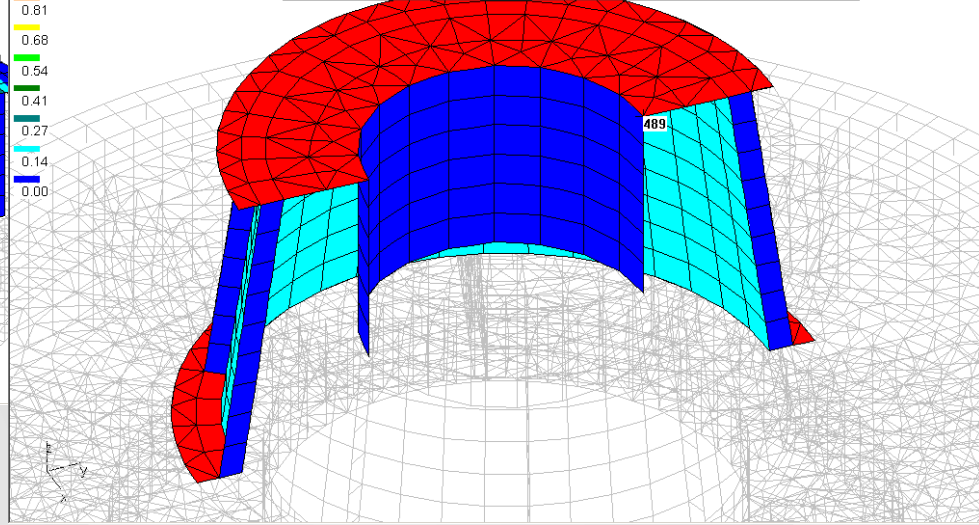

<< home

next >

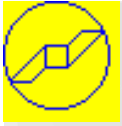

# Dynamic analysis

- Critical rotating speed of the shaft

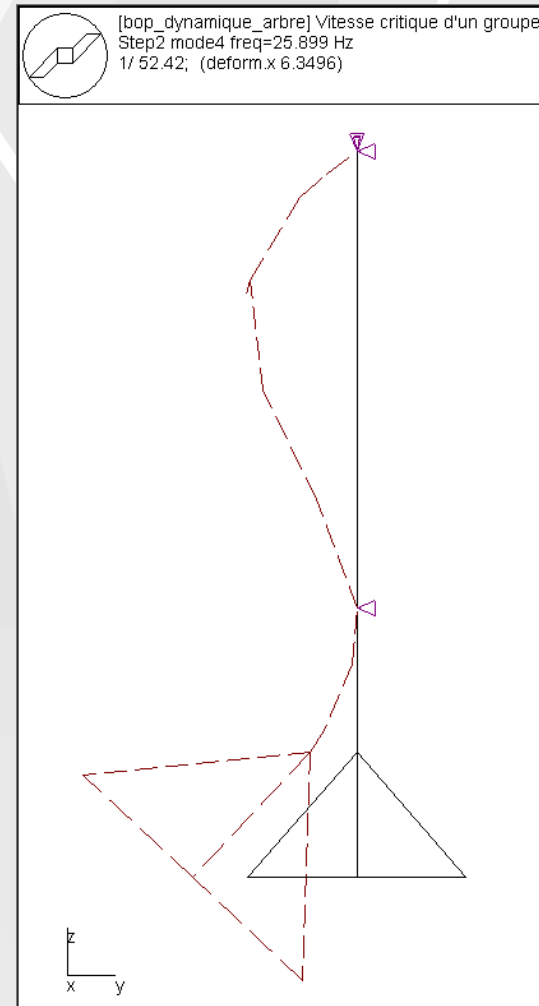
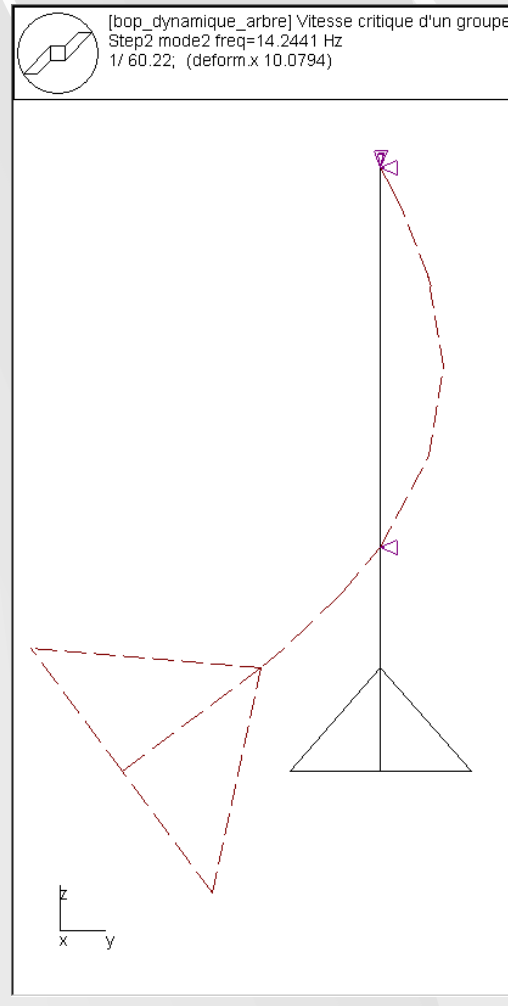
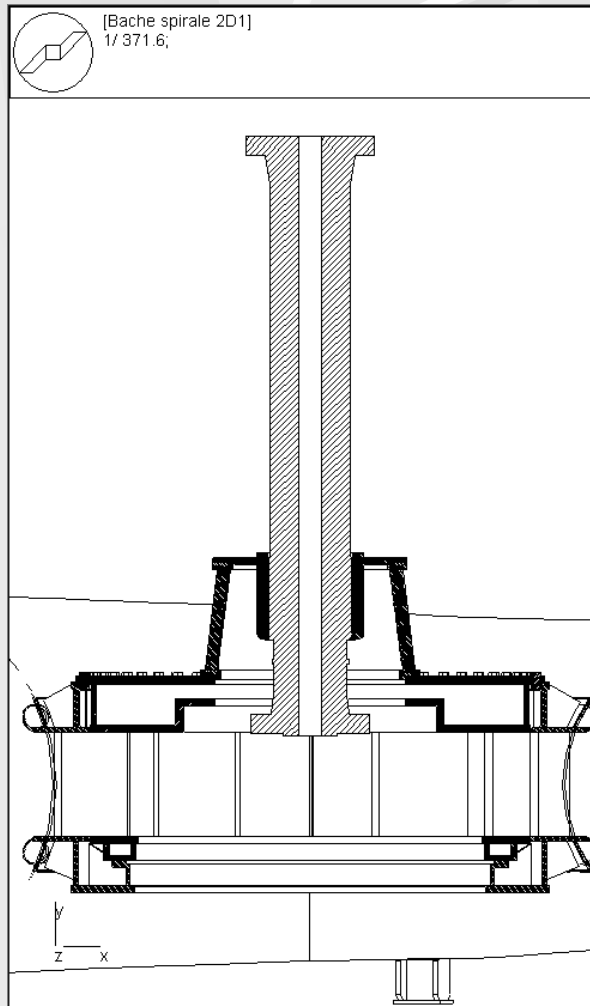

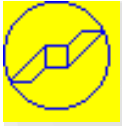

# Vibration analysis

- modal analysis to extract eigen modes:

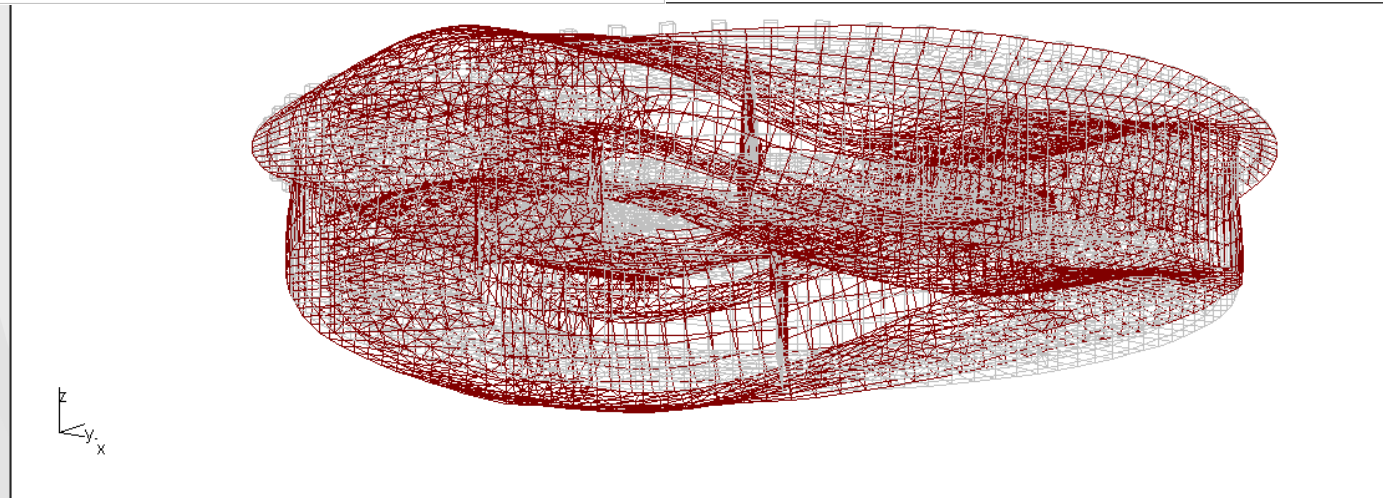
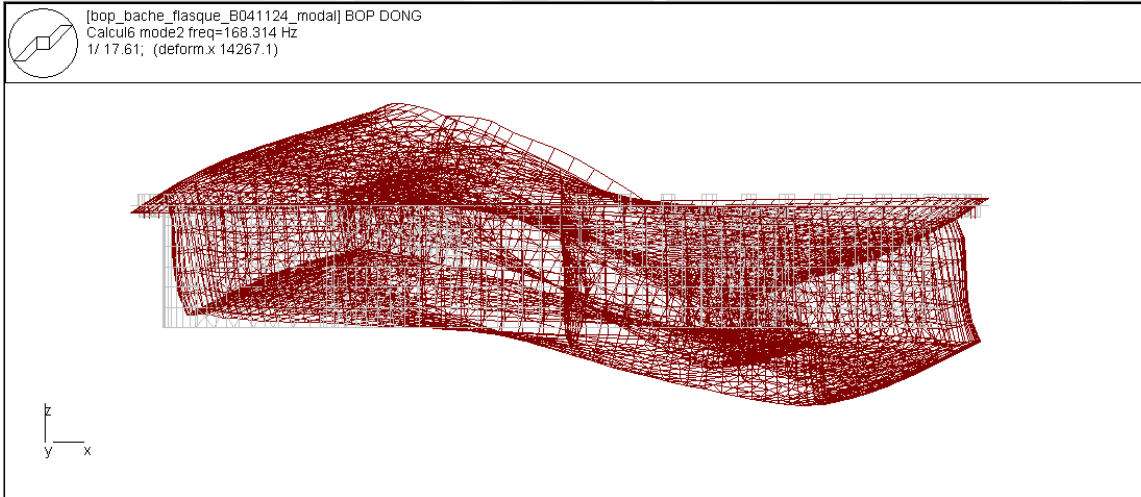

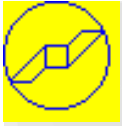

# Parametric study

- +10% increase of stiffener height reduces stresses (-6% - 20%)

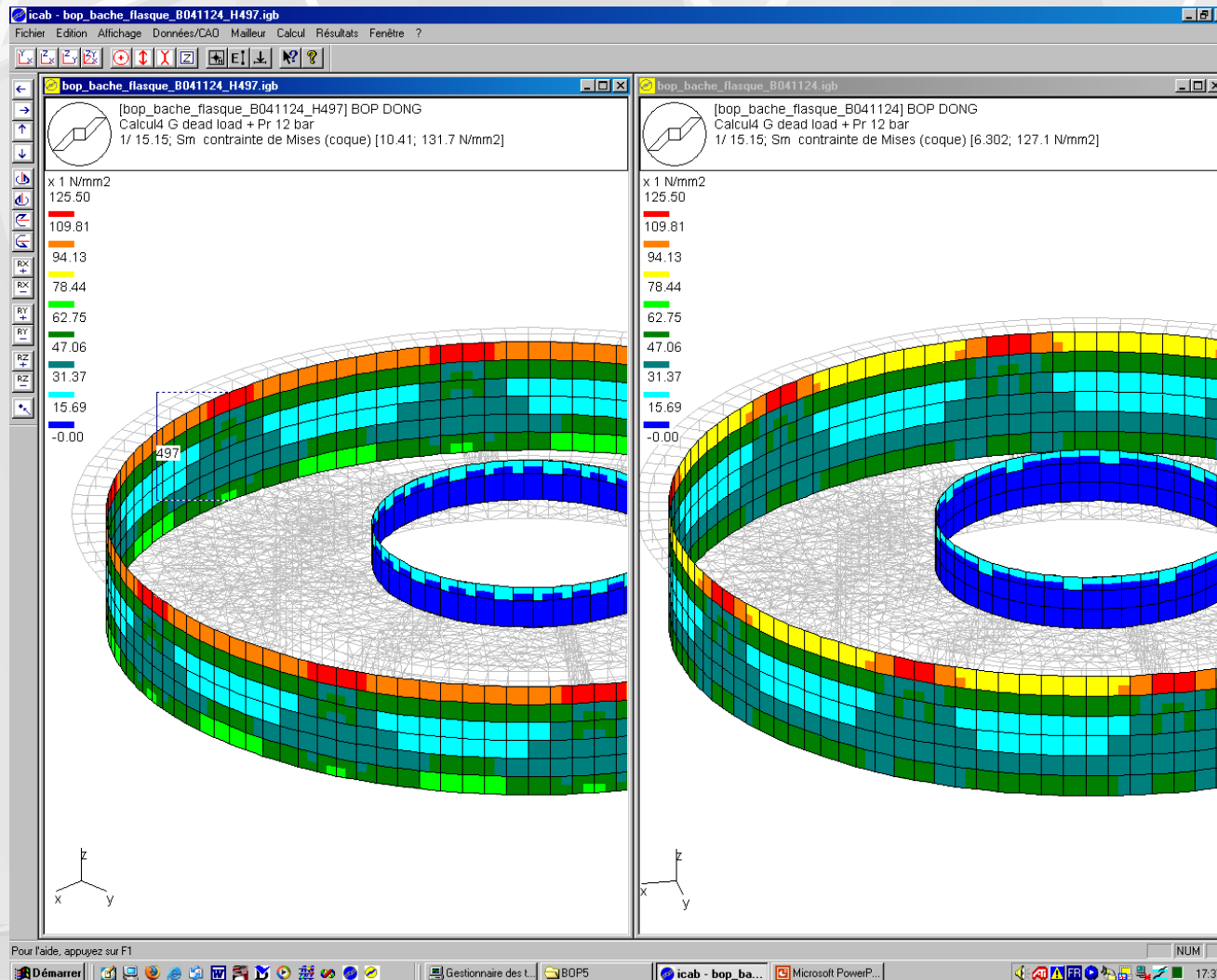

<< home

next >



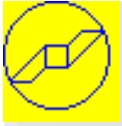

# Welding effect

- Stress concentration in missing welding area

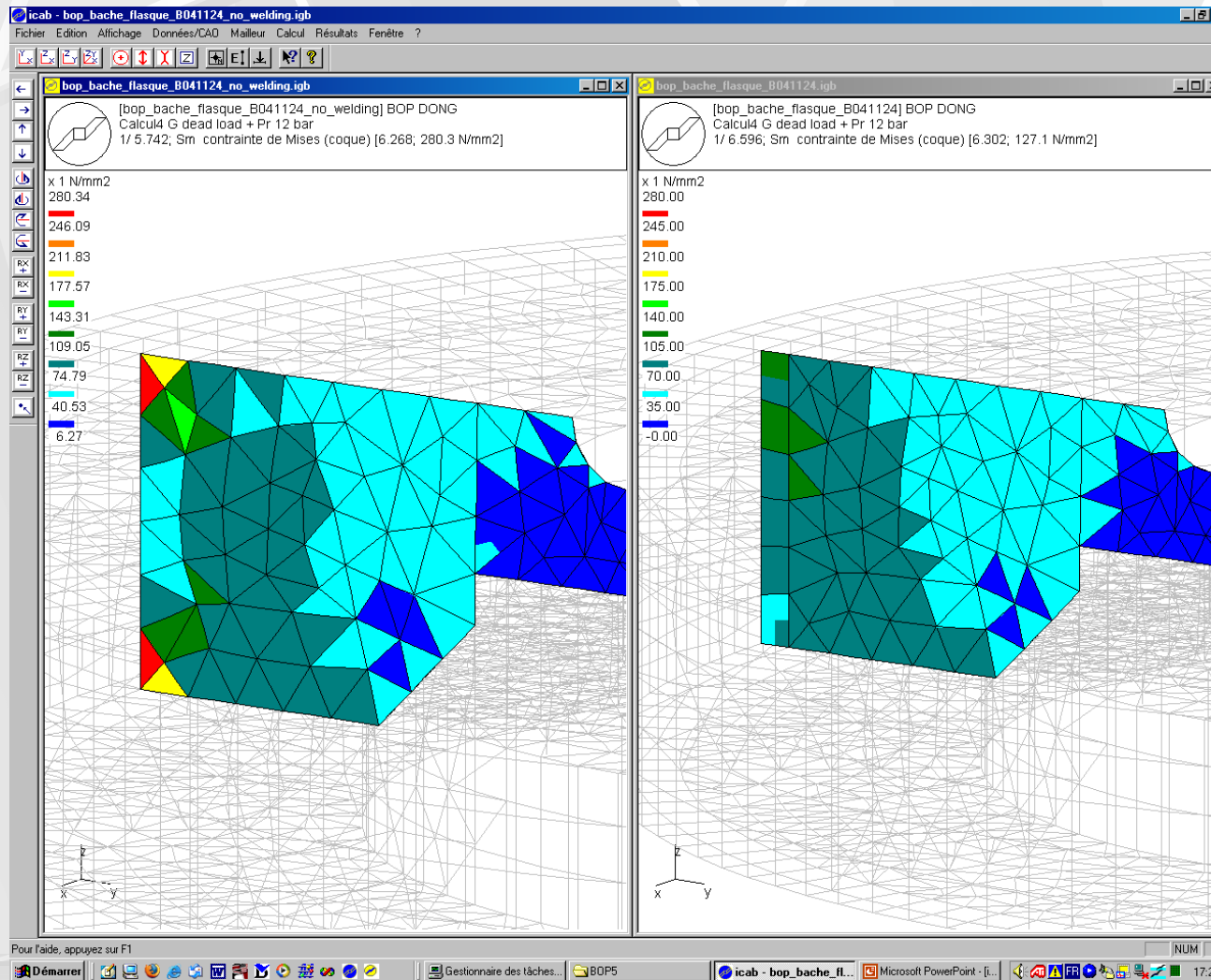

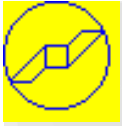

# ICAB

## FEA software used to predict

- deflection
- Stresses
- Dynamic response

**to improve design and reliability**